

**NOTES**

- 1.) ALL STL. MEMBERS COATED W/ ZINC RICH EPOXY THEN FINISHED W/ POLYESTER POWDER COATING.
- 2.)  $1/2'' \times 3 \frac{3}{4}''$  EXPANSION ANCHOR BOLTS PROVIDED.

**SLAT OPTIONS**

- "CEDAR" RECYCLED PLASTIC
- "GREY" RECYCLED PLASTIC
- "REDWOOD" RECYCLED PLASTIC
- "WALNUT" RECYCLED PLASTIC
- OTHER \_\_\_\_\_

	BENCH	DATE DRAWN : 10/07/15	REV.	DRAWING NUMBER	490-60PL	SHEET
		DRAWN BY : RDH	A			
		DATE REV. :				
		REV. BY :				
						1 OF 3

**NOTE:**

- 1.) DURING ASSEMBLY PROCEDURE;  
DO NOT COMPLETELY TIGHTEN HARDWARE.
- 2.) THE ACTUAL PARTS WILL NOT BE NUMBERED.  
NUMBERS ONLY APPLY TO DRAWING.
- 3.) UPON COMPLETION OF ASSEMBLY SQUARE  
ALL COMPONENTS THEN TIGHTEN ALL HARDWARE.
- 4.) MOUNT AND ANCHOR AS SPECIFIED.

**TOOLS REQ'D**

- 3/4" WRENCH
- 9/16 WRENCH
- 1/4" ALLEN WRENCH
- 3/8" DRILL BIT
- 1/2" MASONRY DRILL BIT
- DRILL

**PARTS LIST**

ITEM	QTY	PART NO	DESCRIPTION
1	9	0-143-60PL-01	2" X 3" X 71" INT'R SLAT, PLASTIC
2	2	0-143-60PL-02	2" X 3" X 71" PLASTIC EDGE SLAT
3	2	0-16-60-06	71" SEAT BRACE
4	2	0-490-00-01	CAST ALUM BENCH SUPPORT W/ BACK
5	2	0-57-00-03	CENTER CONTOUR STRAP
6	2	0-57-00-05	END CONTOUR STRAP
7	1	0-57-60-04	71 3/4" PIPE BRACE
8	6	1-12-065	1/2" X 2 1/2" FLT SKT HD CAP SCR
9	8	1-12-116	5/16" X 1" SS BTN SKT HD CAP SCR
10	44	1-13-023	5/16" X 1 1/2" SS BTN SKT HD LAG
11	8	1-20-016	5/16" SS NYLON LOCKNUT
12	52	1-22-017	5/16" SS FLAT WASHER

**KITS PROVIDED**

ITEM	QTY	PART NO	DESCRIPTION
13	1	K-143-60	143-60 SER HARDWARE KIT
14	1	K-ANC0860-4	1/2" X 3 3/4" SS ANCHOR KIT (4PC)
15	1	K-FC0840-6	1/2" CAP HARDWARE KIT (6PC)

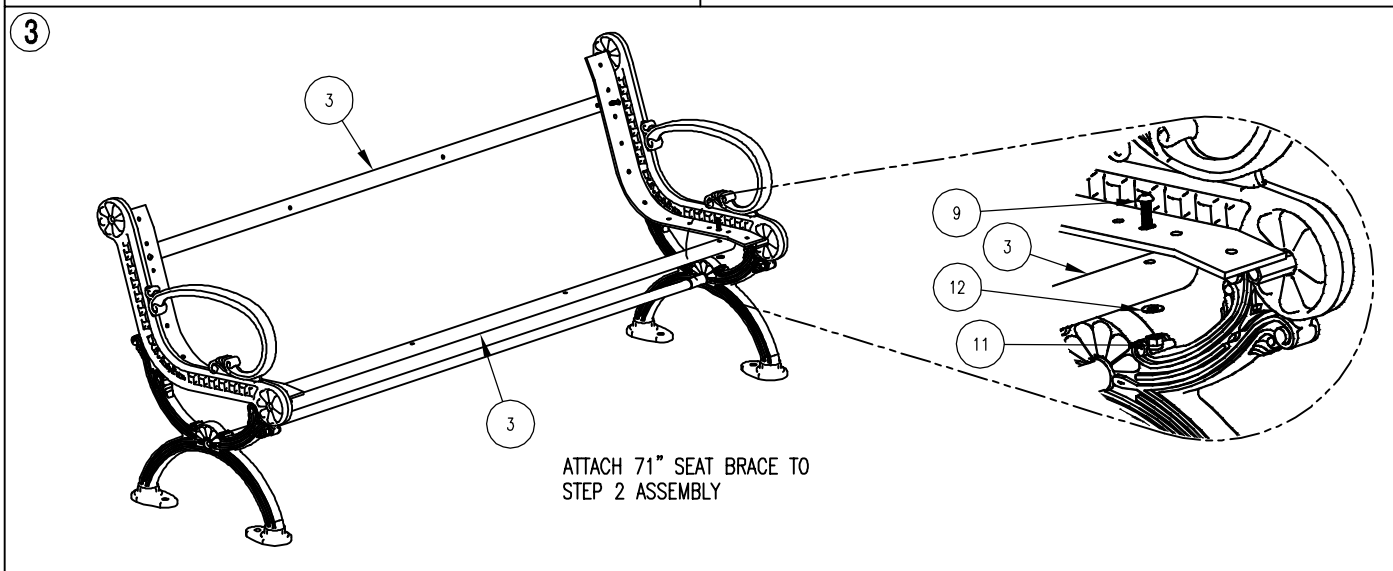
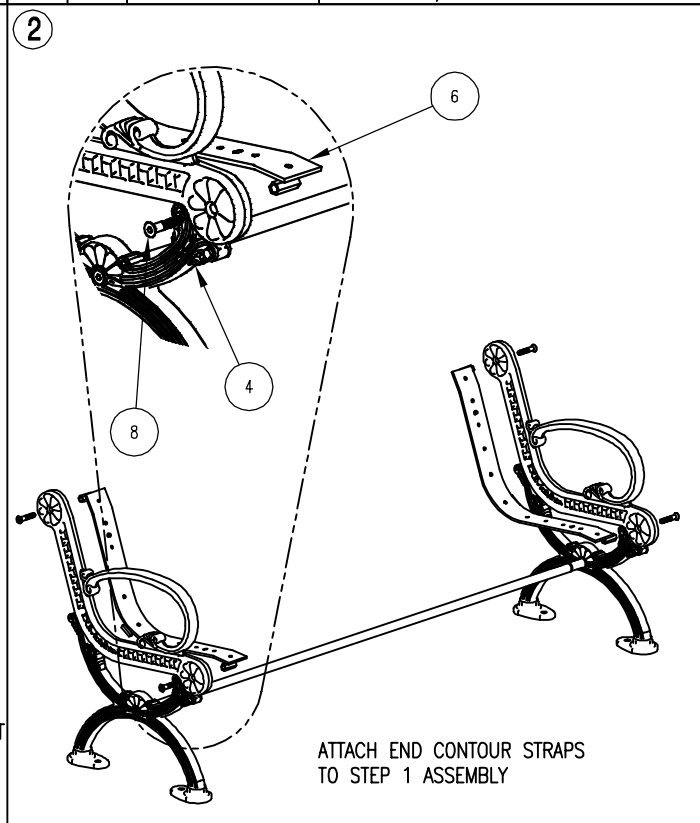
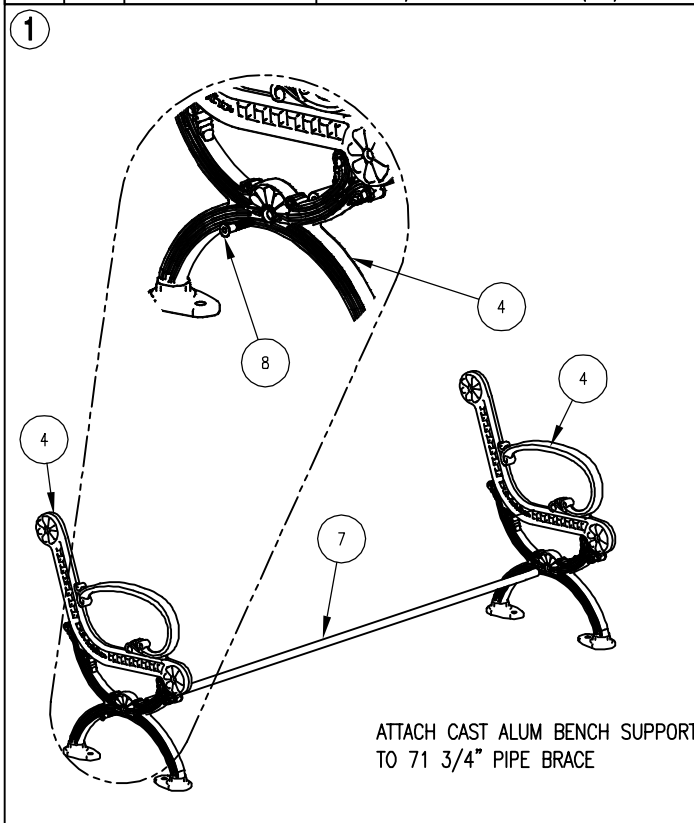

**ASSEMBLY INSTRUCTIONS**

DATE DRAWN : 10/07/15  
 DRAWN BY : RDH  
 DATE REV. :  
 REV. BY :

REV.  
A

DRAWING NUMBER

490-60PL

SHEET  
2 OF 3

4

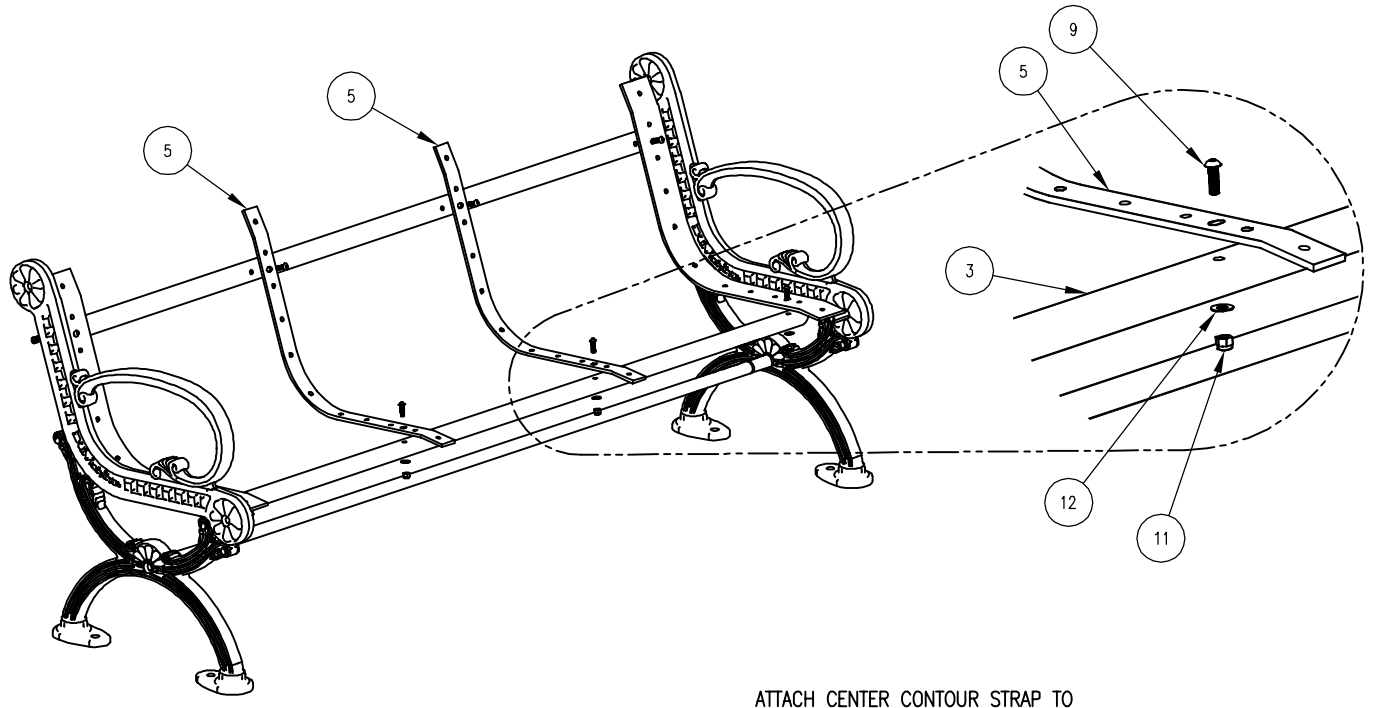

ATTACH CENTER CONTOUR STRAP TO STEP 3 ASSEMBLY.

5

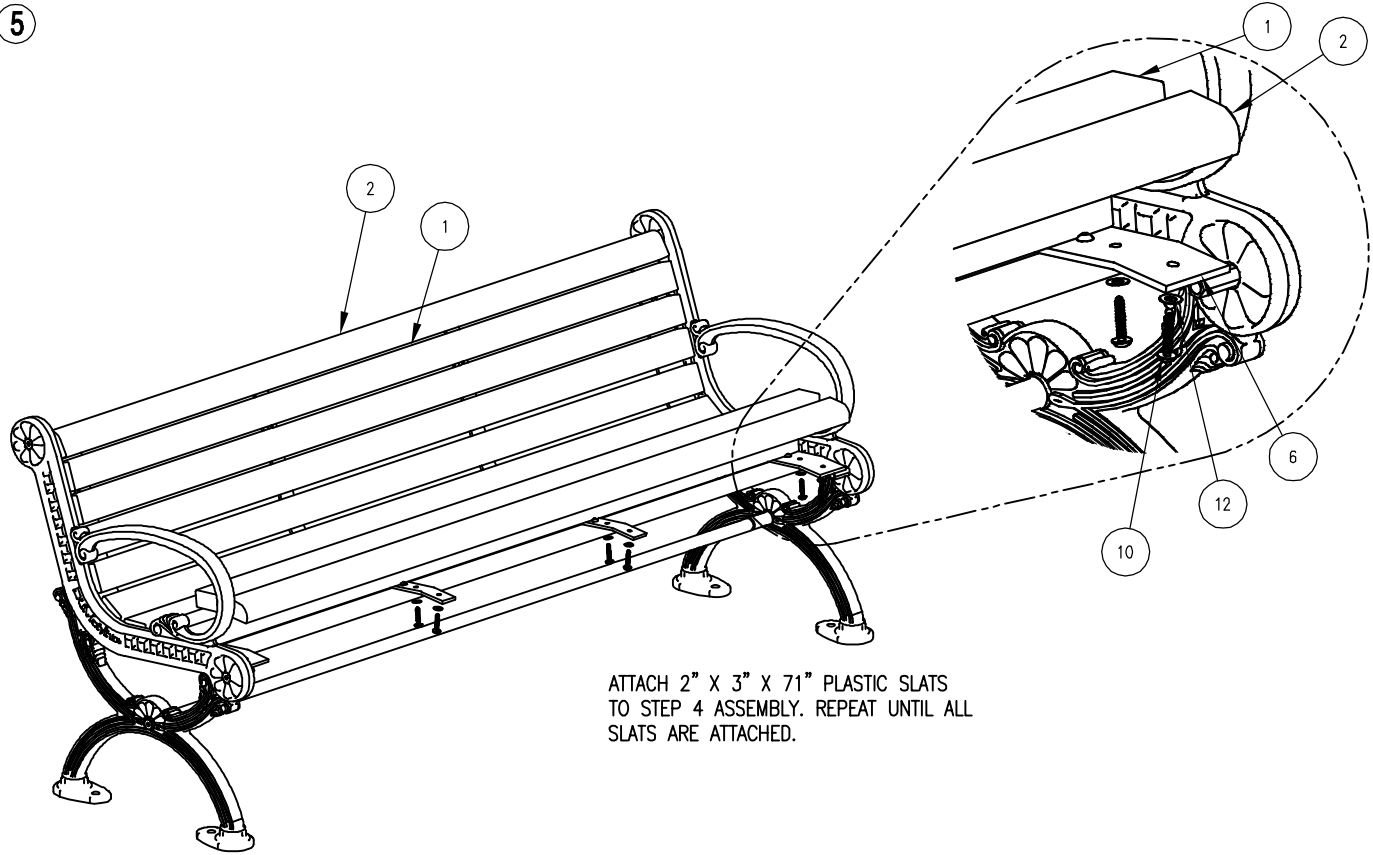

ATTACH 2" X 3" X 71" PLASTIC SLATS TO STEP 4 ASSEMBLY. REPEAT UNTIL ALL SLATS ARE ATTACHED.



ASSEMBLY INSTRUCTIONS

DATE DRAWN : 10/07/15
DRAWN BY : RDH
DATE REV. :
REV. BY :

REV. A

DRAWING NUMBER

490-60PL

SHEET 3 OF 3