

WOOD OPTIONS

- IPE S4S EE
- OTHER _____

NOTES:

- 1.) ALL STL. MEMBERS COATED W/ ZINC RICH EPOXY THEN FINISHED W/ POLYESTER POWDER COATING.
- 2.) 1/2" X 3 3/4" EXPANSION ANCHOR BOLTS PROVIDED FOR S-2 OPTION.

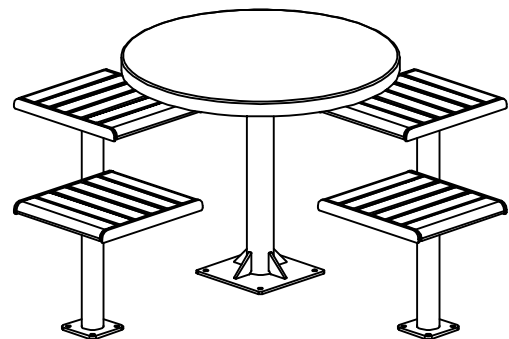

NOTES:

- 1.) DURING ASSEMBLY PROCEDURE;
DO NOT COMPLETELY TIGHTEN HARDWARE.
- 2.) THE ACTUAL PARTS WILL NOT BE NUMBERED.
NUMBERS ONLY APPLY TO DRAWING.
- 3.) UPON COMPLETION OF ASSEMBLY SQUARE
ALL COMPONENTS THEN TIGHTEN ALL HARDWARE.
- 4.) MOUNT AND ANCHOR AS SPECIFIED.

TOOLS REQ'D

- 3/4" WRENCH
- 1/4" WRENCH
- 1/2" MASONRY DRILL BIT
DRILL

PARTS LIST FOR S-2

ITEM	QTY	PART NO	DESCRIPTION
1	16	0-294-00-04	15 1/4" SEAT SLAT, WOOD
2	4	0-295-00-03	BKLS STL SEAT FRAME FOR WOOD
3	1	0-296-00-01/S-2	TABLE SUPT FRAME FOR SURFACE MT
4	4	0-296-00-02/S-2	STL PEDESTAL SEAT SUPPORT, PLATES
5	1	0-296-36-03	36" DIA STL TABLE TOP
6	12	1-11-042	1/2" X 1 1/2" SS CGE BOLT
7	32	1-16-023	#14 X 7/8 SS HX WASH HD 'A' SLTD WD SCREW
8	12	1-20-015	1/2" SS NYLON LOCKNUT
9	12	1-22-015	1/2" SS FLAT WASHER

KITS PROVIDED FOR S-2

ITEM	QTY	PART NO	DESCRIPTION
10	5	K-ANC0860-4	1/2" X 3 3/4" SS ANCHOR KIT (4PC)
11	3	K-CG0824-4L	1/2" CGE BOLT HARDWARE KIT (4)
12	2	K-WS1414-16	#14 HEX HD WASH WOOD SCR (16PC)

1 ATTACH TABLE TOP TO TABLE SUPPORT.

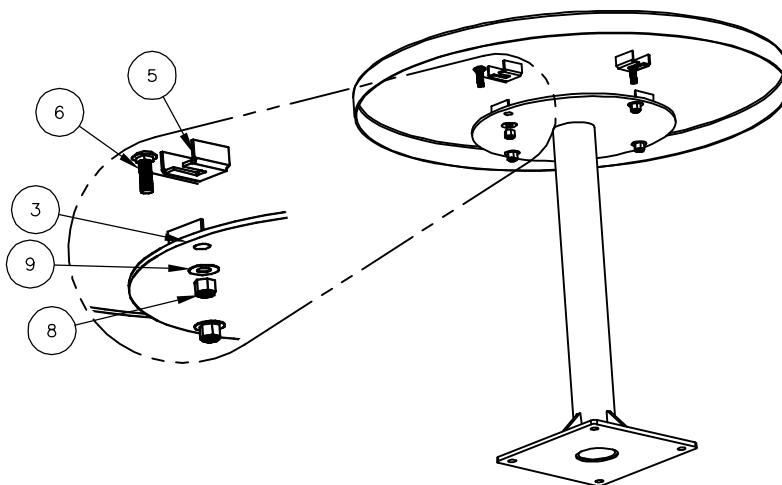

2 ATTACH STL. SEAT FRAME TO SEAT SUPPORT.

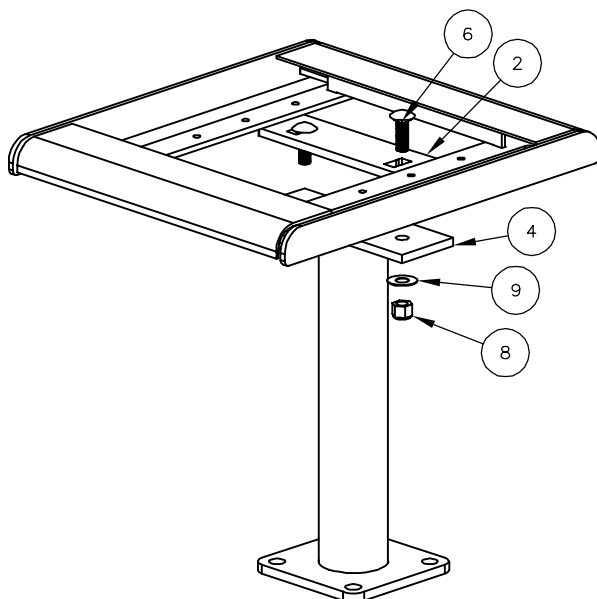

3 ATTACH SLATS TO STEP #2.

