

**NOTES**

- 1.) ALL STL. MEMBERS COATED W/ ZINC RICH EPOXY THEN FINISHED W/ POLYESTER POWDER COATING.
- 2.) 1/2" X 3 3/4" EXPANSION ANCHOR BOLTS PROVIDED.
- 3.) CUSTOM LETTERING AVAILABLE FOR RECESSED SIDE PANELS ( TOTAL OF 37 SPACES ).

CUSTOM LETTERING ( 37 SPACES ) \_\_\_\_\_

**SLAT OPTIONS**

- ANTIQUE MAHOGANY TEXTURED
- BRAZILIAN WALNUT TEXTURED
- OTHER \_\_\_\_\_

**NOTE:**

- 1.) DURING ASSEMBLY PROCEDURE;  
DO NOT COMPLETELY TIGHTEN HARDWARE.
- 2.) THE ACTUAL PARTS WILL NOT BE NUMBERED.  
NUMBERS ONLY APPLY TO DRAWING.
- 3.) UPON COMPLETION OF ASSEMBLY SQUARE  
ALL COMPONENTS THEN TIGHTEN ALL HARDWARE.
- 4.) MOUNT AND ANCHOR AS SPECIFIED.

**TOOLS REQ'D**

- 3/4" WRENCH
- 1/2" WRENCH
- 5/16" ALLEN WRENCH
- 1/4" ALLEN WRENCH
- 3/16" ALLEN WRENCH
- 1/2" MASONRY DRILL BIT
- DRILL

**PARTS LIST**

ITEM	QTY	PART NO	DESCRIPTION
1	2	0-140-00-01	CAST IRON BENCH SUPPORT
2	9	0-143-60TX-01	2" X 3" X 71" INT'R SLAT, TX
3	2	0-143-60TX-02	2" X 3" X 71" EDGE SLAT, TX
4	2	0-16-60-06	71" SEAT BRACE
5	2	0-57-00-03	CENTER CONTOUR STRAP
6	2	0-57-00-05	END CONTOUR STRAP
7	1	0-57-60-04	71 3/4" PIPE BRACE
8	6	1-12-065	1/2" X 2 1/2" FLT SKT HD CAP SCR
9	8	1-12-116	5/16" X 1" SS BTN SKT HD CAP SCR
10	44	1-13-023	5/16" X 1 1/2" SS BTN SKT HD LAG
11	8	1-20-016	5/16" SS NYLON LOCKNUT
12	60	1-22-017	5/16" SS FLAT WASHER

**KITS PROVIDED**

ITEM	QTY	PART NO	DESCRIPTION
13	1	K-143-60	143-60 SER HARDWARE KIT
14	1	K-ANC0860-4	1/2" X 3 3/4" SS ANCHOR KIT (4PC)
15	1	K-FC0840-6	1/2" CAP HARDWARE KIT (6PC)

**1** ATTACH CAST BENCH SUPPORT TO 71 3/4" PIPE BRACE.

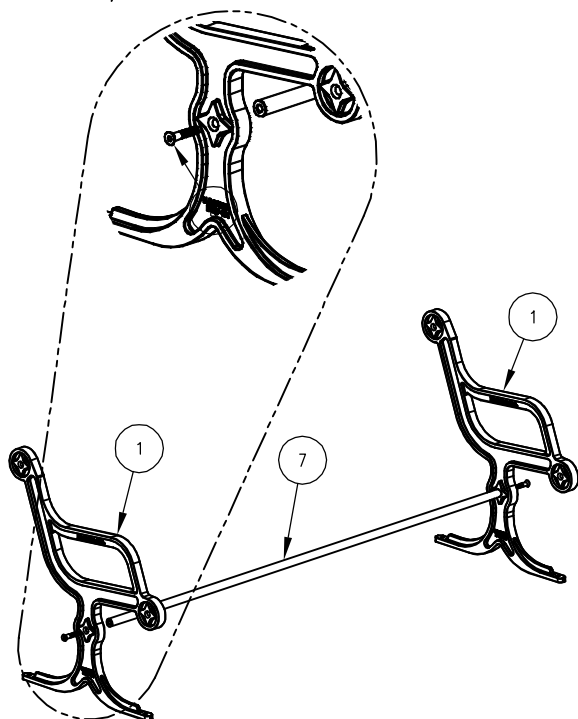

**2** ATTACH END CONTOUR STRAPS TO STEP 1.

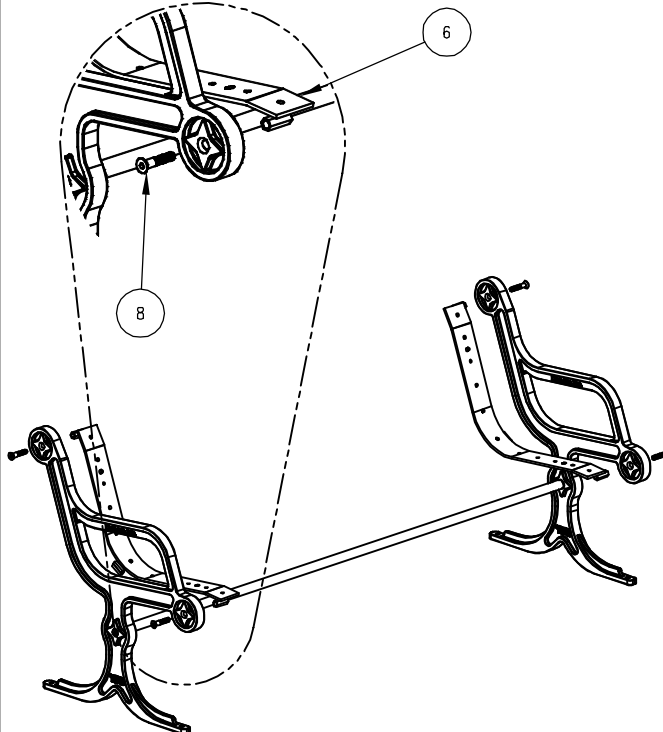

**3** ATTACH 71" SEAT BRACE TO STEP 2.

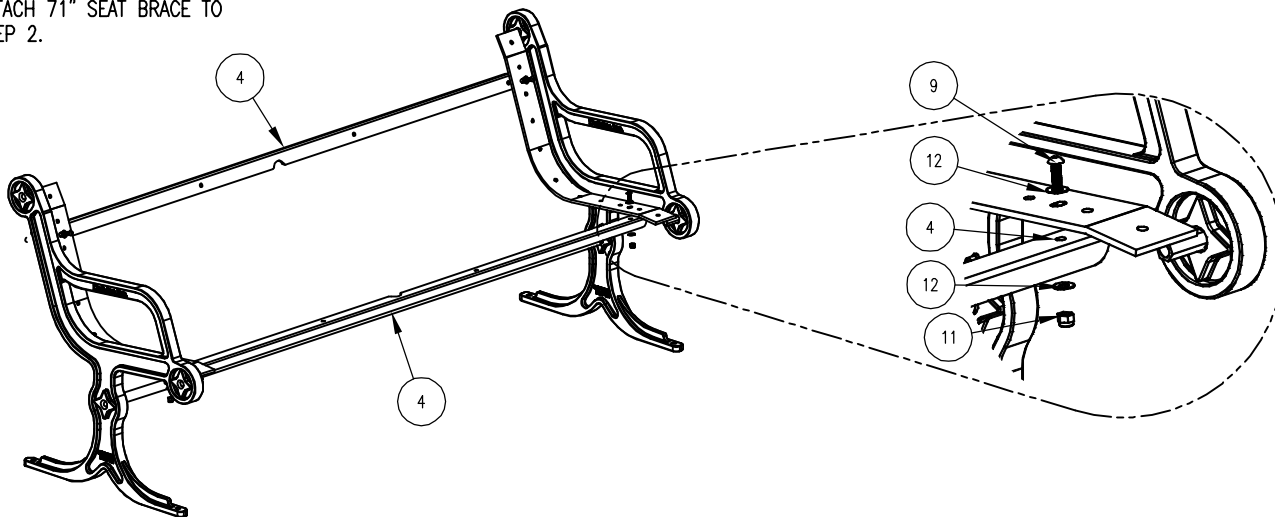

4 ATTACH CENTER CONTOUR STRAPS TO STEP 3.

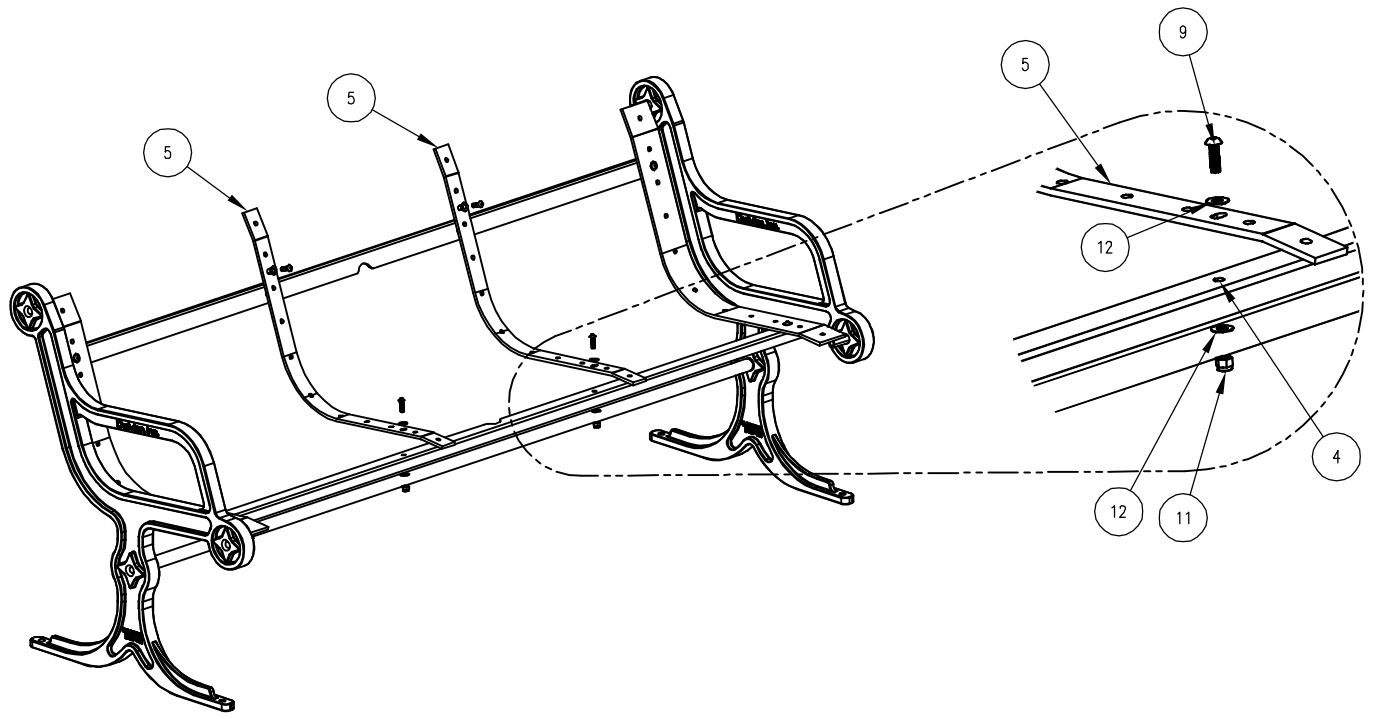

5 ATTACH 2" X 3" X 71" PLASTIC SLATS TO STEP 4.

